

# Positivo

(Naturale)

# Origami

(Tensegrity)

# Metallic

(Lappato)

6 COLOURS

6 SIZES

3 SURFACES

Materia is conceived to introduce a new expression of ceramics. A noble material with a great history relaunches its creative potential thanks to the graphic technique and the diverse esthetics of materials like metal, stone and ceramics itself.

**Z**  
COLLECTION

Materia nasce dall'idea sviluppata in Piemme per una nuova espressione della ceramica, una materia nobile con una grande storia creativa che ritrova e rilancia il proprio estro originario e, grazie alla sua tecnica grafica, analizza l'estetica di materie differenti, come il metallo, la pietra e la ceramica stessa,

Mit „Materia“ möchte Piemme der Keramik einen neuen Ausdruck verleihen. Das edle und geschichtsträchtige Material findet zurück zu seinen Wurzeln, erfindet sich neu und analysiert mit seiner graphischen Technik seine eigene Ästhetik sowie die anderer Materialien wie Metall und Stein.

« Materia » est l'aboutissement d'une idée développée par Piemme: donner à la céramique, matière noble, riche d'une histoire nourrie de créativité, une nouvelle forme d'expression où elle puisse retrouver son style originel. Ses techniques graphiques lui permettent d'analyser les dimensions esthétiques de matières comme le métal, la pierre ainsi que la céramique.

## Materia



Spazi Residenziali  
Residential Spaces

P. 5

Spazi Pubblici  
Public Areas

P. 21

Informazioni Tecniche  
Technical Information

P. 45

La forza espressiva della ceramica secondo Piemme, riesce a dare nuova eleganza ed appeal ad una materia di per sé fredda come il metallo, proprio grazie alla possibilità di fondervi e compenetrarvi altri aspetti di una materia affascinante come la pietra, arricchendo con grande profondità le nuances più flat del metallo stesso.

The expressive force of Piemme ceramics bestows new elegance and appeal on metal, an intrinsically cold material, through this ability to merge and mingle it with other aspects native to stone with all its natural beauty, thus enhancing the flatter shades of metal with great depth.

Mit ihrer Ausdruckskraft schafft es die Keramik von Piemme, einem an sich kalten Material wie Metall eine neue Eleganz und Ausstrahlung zu verleihen. Die Keramik verschmilzt mit dem Metall und bringt die Eigenschaften eines weiteren faszinierenden Materials mit ein: des Steins. So erhält das eher flach wirkende Metall mehr Tiefe.

Cette force expressive de la céramique revue par Piemme réussit à insuffler une nouvelle élégance et un nouvel attrait à une matière comme le métal, intrinsèquement froide. Elle y parvient parce qu'elle peut y incorporer d'autres aspects de ce matériau fascinant qu'est la pierre, enrichissant ainsi de ses nuances profondes celles, plus plates, du métal.

# Spazi Residenziali

Residential Spaces  
Wohnanlagen  
Espaces Résidentiels



COLORI / COLOURS

AMBIENTI / AMBIENT

PAGINA / PAGE

Deep / Shimmer

Living

6

Deep

Living

8

Reflex

Living

10

Opal / Nacre

Bathroom

13

Shimmer / Rust

Bathroom

17

Materia  
Residential Spaces

5







## Opal / Nacre

30x60 - 12"x24" Lappato Rettificato / 30x60 - 12"x24" Garage Naturale Rettificato

Ceramics is restored to its status as a fine material, now with new vitality and a striking personality. The "Materia" collection, with its expressive peculiarities and 3D structures, is superior to any other ceramic surface.

Das edle keramische Material findet einen neuen Lebens und eine besondere Persönlichkeit. Die Serie „Materia“ unterscheidet sich mit ihren ästhetischen Merkmalen und ihren 3D-Dekoren von jeder anderen Oberfläche aus Keramik.

La noble matière céramique retrouve dès lors sa sève vitale et sa personnalité marquée. Ses particularités expressives et ses structures 3D permettent à la série « Materia » de se distinguer des autres surfaces céramiques.

La nobile materia ceramica ritrova una nuova linfa vitale e una spiccata personalità. La serie "Materia" con le sue peculiarità espressive e le strutture 3d emerge rispetto qualunque altra superficie ceramica.

60x60 - 24"x24" Naturale Rettificato



Materia  
Residential Spaces





## Shimmer / Rust

Starting from the tactile effects inspired by the various glossy or oxidised metals and the natural look of stone, in "Materia" our designers have created a new material.

Ausgehend von der Wirkung unterschiedlicher, glänzender oder oxidiertes Metalle und von der natürlichen Optik des Steins haben unsere Designer „Materia“ wie einen neuen Stoff geschaffen.

60×119,5 - 24"×47½" Naturale Rettificato

S'appuyant sur les effets de matières, brillants ou oxydés, suggérés par les différents métaux, ainsi que sur l'aspect naturel de la pierre, nos designers ont créé une nouvelle matière : « Materia ».

Partendo dagli effetti materici suggeriti dai differenti metalli, lucenti o ossidati e dall'aspetto naturale della pietra, i nostri designer hanno creato una nuova "Materia".

119,5×119,5 - 47½"×47½" Naturale Rettificato

60×60 - 24"×24" Jade Naturale Rettificato



Materia  
Residential Spaces

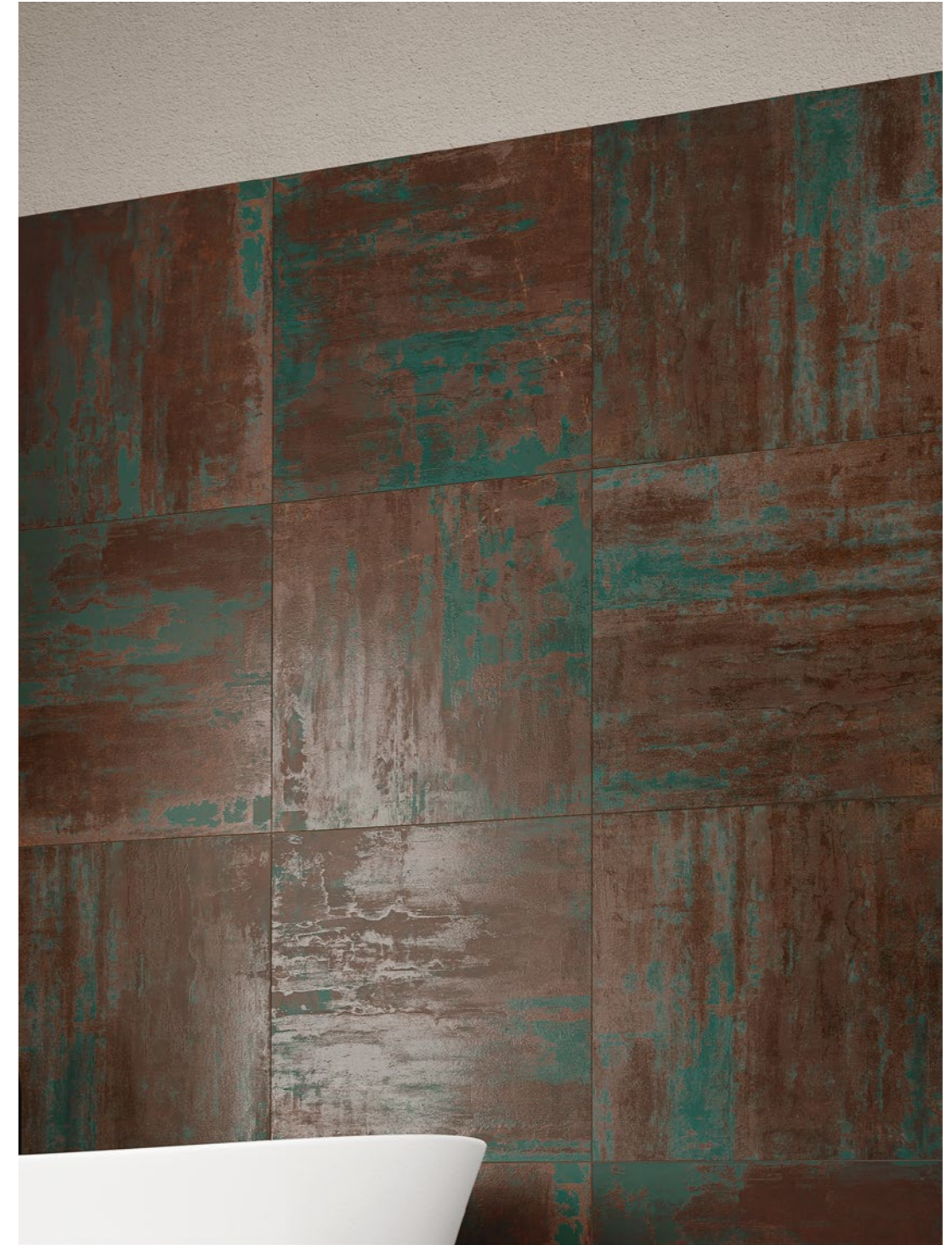

# Spazi Pubblici

Public Areas  
Öffentliche Räumlichkeiten  
Espaces Publics



COLORI / COLOURS

AMBIENTI / AMBIENT

PAGINA / PAGE

Deep / Rust / Opal

Restaurant

23

Opal / Deep

Museum Lobby

24

Reflex / Nacre

Food Court

29

Reflex

Bathroom

33

Rust / Shimmer

Museum Restaurant

36

Reflex

Museum Cafè

40

## Deep / Rust / Opal

An unusual effect, creating surfaces that merge metal, Corten steel, stone and ceramic in a refined, contemporary look.

Eine ganz neue Wirkung für Oberflächen, die Metall, Cortenstahl, Stein und Keramik in einer raffiniertmodernen Ästhetik verbinden.

Un effet inédit sur des surfaces où métal, corten, pierre et céramique se conjuguent pour créer une esthétique raffinée et contemporaine.

Un effetto inedito per superfici che coniugano metallo, corten, pietra e ceramica, in un'estetica raffinata e contemporanea.

30×60 - 12"×24" Garage Naturale Rettificato / 60×119,5 - 24"×47½" Naturale Rettificato / 119,5×119,5 - 47½"×47½" Naturale Rettificato







## Nacre

Thanks to sophisticated production technologies, "Materia" combines the ground look typical of handpolished metal with the small flaws that denote genuine craftsmanship.

Dank ausgeklügelter Produktionstechniken vereint „Materia“ die typische Glätte von handgeschliffenem Metall mit den kleinen Schönheitsfehlern von Handwerksprodukten.

Grâce à des technologies de production de pointe, « Materia » associe l'effet de rodage typique du métal poli à la main aux petites imperfections propres au travail artisanal.

Grazie a sofisticate tecnologie produttive "Materia" abbina l'effetto di smerigliatura tipico del metallo levigato a mano, alle piccole imperfezioni della lavorazione artigianale.

60×119,5 - 24"×47½" Lappato Rettificato



Materia  
Public Areas





## Reflex

The unusual aesthetic synthesis generated by this blending of materials has given us a collection rich in contemporary combinations.

Aus der neuartigen ästhetischen Synthese von Stoffen entsteht eine facettenreiche und moderne Kollektion.

La synthèse esthétique née de la fusion des matières a engendré une collection riche de combinaisons contemporaines.

La sintesi estetica inedita nata dalla fusione tra materie, ha generato una collezione ricca di combinazioni contemporanee.

30x60 - 12"x24" Lappato Rettificato / 30x119,5 - 12"x47½" Raku Warm Naturale Rettificato / 60x60 - 24"x24" Naturale Rettificato



Materia  
Public Areas





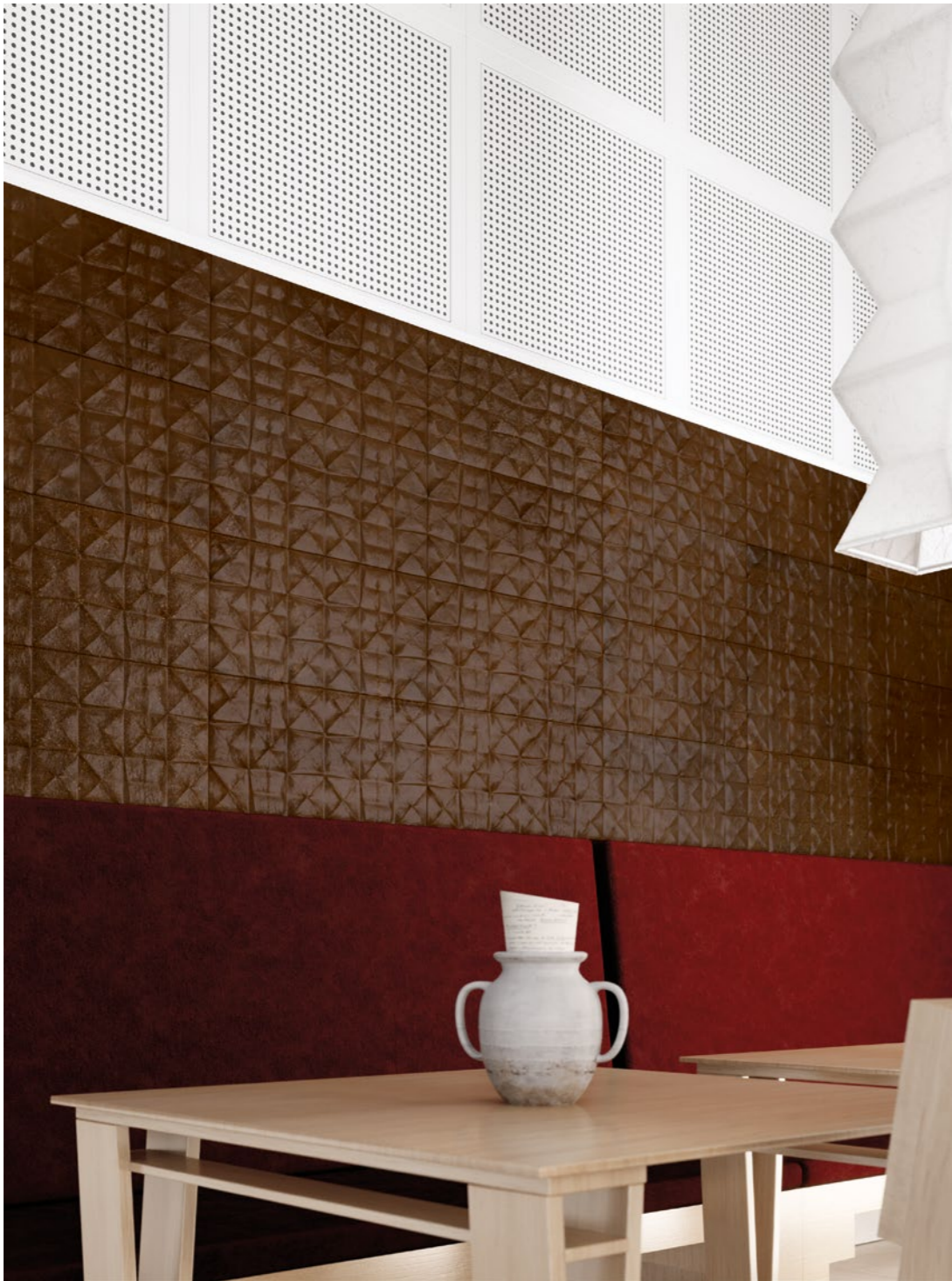



## Reflex

The perfect solution for coordinating an interior and outdoor mood with a floor that maintains the same design as the interior version, providing strength, style and durability.

Die perfekte Lösung für eine koordinierte Oberfläche innen wie außen, mit einem Bodenbelag, der mit dem gleichen Design der Version für Innenräume Beständigkeit und Langlebigkeit anbietet.

La solution parfaite pour coordonner intérieur et extérieur par un revêtement de sol qui offre style, résistance et solidité.

La soluzione perfetta per coordinare il mood interno ed esterno con un pavimento che offre resistenza, stile e durabilità.

90x90 - 36"x36" Grip Rettificato 20MM

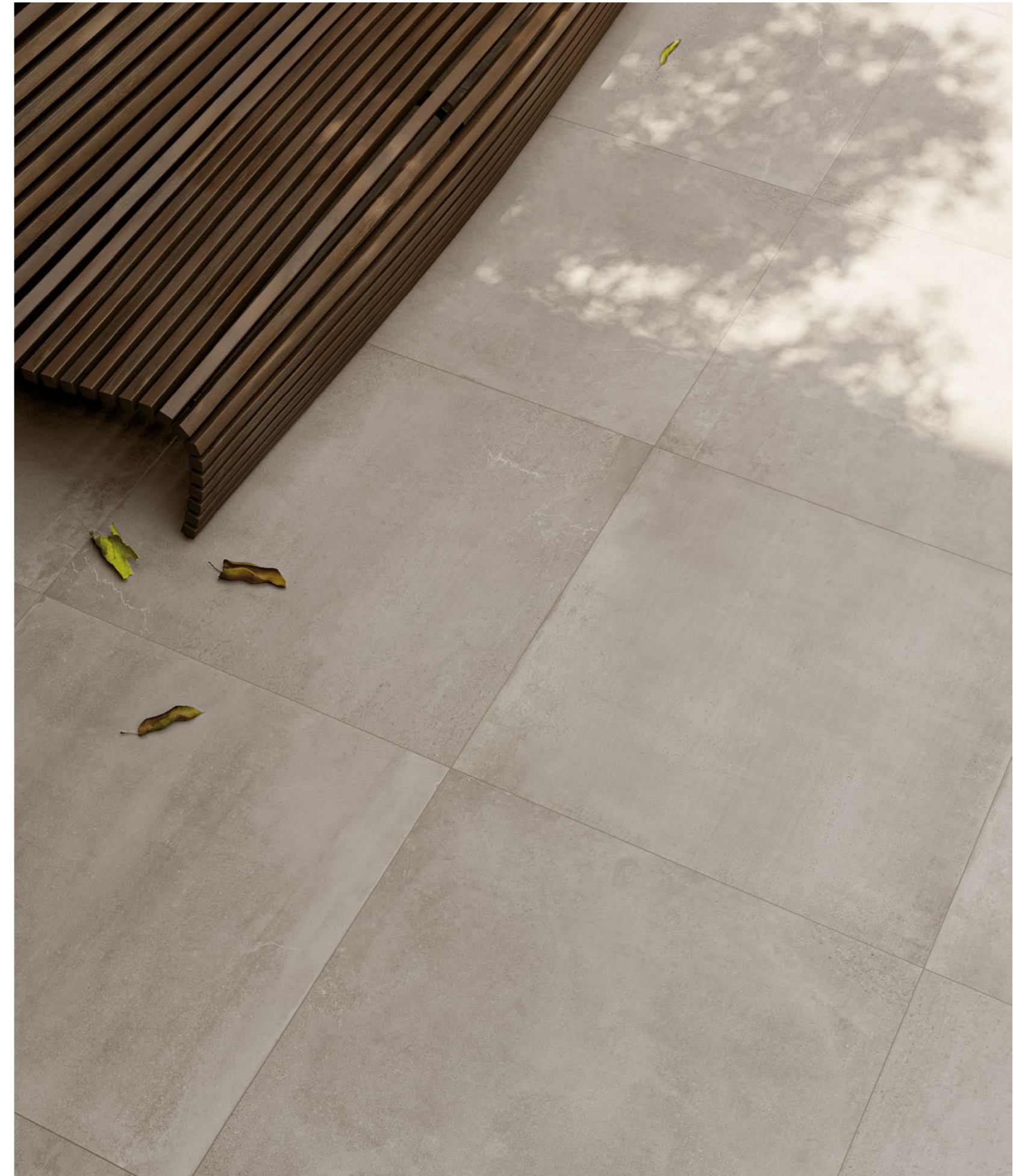

Materia  
Public Areas

# Informazioni Tecniche

6

Colori  
Colours  
Farben  
Couleurs

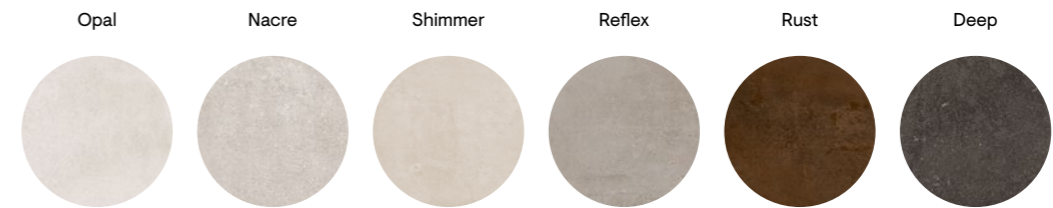

6

Formati  
Sizes  
Formate  
Formats

\* 119,5×119,5   \*60×119,5   90×90   \*89,5×89,5   \*60×60   \*30×60  
47½"×47½"   24"×47½"   36"×36"   35¼"×35¼"   24"×24"   12"×24"



\*Attenzione: verificare in fase di ordine il codice e l'imballo / Note: In the ordering phase please check code and packaging /  
Bitteachten: Beim Bestellen bitte die Kodenummer und die Verpackung kontrollieren / Attention : Merci de vérifier emballage et la référence au moment de la commande

3

Spessori  
Thickness  
Stärke  
Epaisseur

≅9   ≅9,5   ≅20

3

Superfici  
Surfaces  
Oberflächen  
Surfaces

Naturale Lappato Grip

2

Strutture 3D  
3D structures  
Strukturen  
Décorations en relief

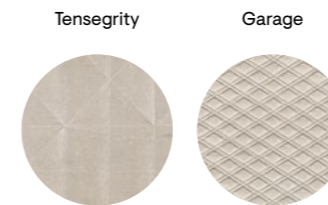

i

Effetto Pietra - Metallo  
Stone Look - Metal  
Natursteinoptik - Metall  
Effet Pierre - Métal

Rivestimento  
Wall Tiles  
Wandfliesen  
Revêtement

Pavimento  
Floor Tiles  
Bodenfliesen  
Sol

Gres fine porcellanato ad impasto colorato  
Coloured-body fine porcelain stoneware  
Feinsteinzeug aus farbiger Masse  
Grès cérame fin à pâte colorée

Tecnologia digitale  
Digital technology  
Digital technologie  
Technologie numérique





# Opal

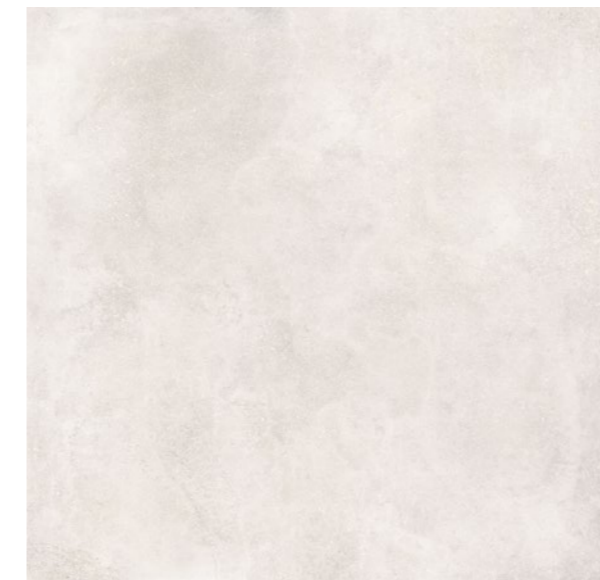

119,5x119,5 - 47 1/4"x47 1/4"  
**03071** | Materia Opal Nat/Ret  
**03075** | Materia Opal Lap/Ret



\*89,5x89,5 - 35 1/4"x35 1/4"  
**03468** | Materia Opal Nat/Ret  
**03473** | Materia Opal Lap/Ret

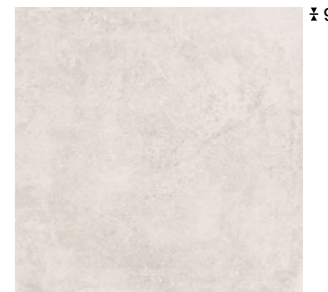

60x60 - 24"x24"  
**02847** | Materia Opal Nat/Ret  
**02853** | Materia Opal Lap/Ret

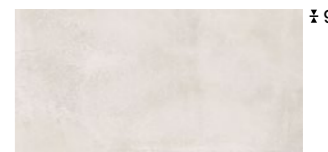

30x60 - 12"x24"  
**02827** | Materia Opal Nat/Ret  
**02834** | Materia Opal Lap/Ret

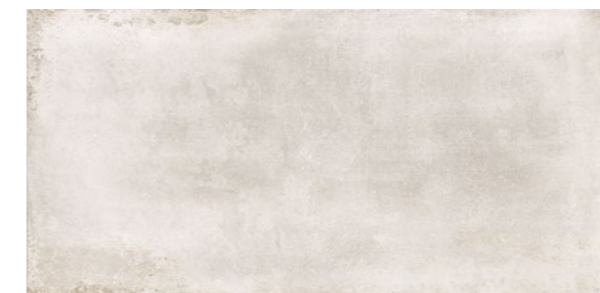

\*60x119,5 - 24"x47 1/4"  
**02859** | Materia Opal Nat/Ret  
**02866** | Materia Opal Lap/Ret



60x60 - 24"x24"  
**02981** | Materia Platinum Nat/Ret  
(mix 4 graphics)

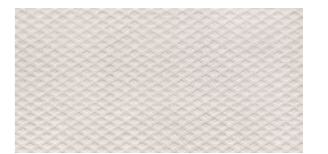

30x60 - 12"x24"  
**02936** | Materia Garage Opal Nat/Ret





30x60 - 12"x24"  
**03079** | Materia Tensegrity Opal Nat/Ret

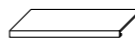
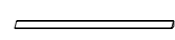

\*30x119,5 - 12"x47 1/4"  
**02944** | Materia Raku Warm Nat/Ret  
(handcrafted decor)

\* formato modulare con 60x60 e 30x60 / modular size, can be matched with 60x60 and 30x60 size /  
modulares, sprich mit dem Format 60x60 und 30x60 kombinierbares Format / format modulaire pouvant être coordonné au format 60x60 et 30x60

Pezzi speciali Special pieces  Battiscopa 4,5x60 € 9,5  Gradino Costa Retta 30x119,5 € 9,5  Bacchetta Jolly 1,5x119,5 € 9,5  Unghia Jolly 1,5x1,5 € 9,5



# Nacre



± 9,5

\*60x119,5 - 24"x47 1/2"

**02861** | Materia Nacre Nat/Ret  
**02867** | Materia Nacre Lap/Ret



± 9,5

60x60 - 24"x24"

**02848** | Materia Nacre Nat/Ret  
**02854** | Materia Nacre Lap/Ret



60x60 - 24"x24"

**02980** | Materia Gold Nat/Ret  
(mix 4 graphics)



\*30x119,5 - 12"x47 1/2"

**02944** | Materia Raku Warm Nat/Ret  
(handcrafted decor)



± 9,5

30x60 - 12"x24"

**02828** | Materia Nacre Nat/Ret  
**02836** | Materia Nacre Lap/Ret



30x60 - 12"x24"

**02937** | Materia Garage Nacre Nat/Ret

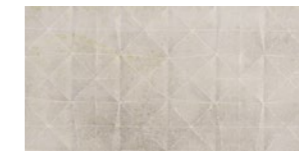

30x60 - 12"x24"

**03081** | Materia Tensegrity Nacre Nat/Ret

\* formato modulare con 60x60 e 30x60 / modular size, can be matched with 60x60 and 30x60 size /  
modulares, sprich mit dem Format 60x60 und 30x60 kombinierbares Format / format modulaire pouvant être coordonné au format 60x60 et 30x60

Pezzi speciali  
Special pieces



Battiscopa 4,5x60 ± 9,5

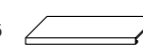

Gradino Costa Retta 30x119,5 ± 9,5

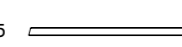

Bacchetta Jolly 1,5x119,5 ± 9,5

↳ Unghia Jolly 1,5x1,5 ± 9,5



# Shimmer



119,5x119,5 - 47 1/4"x47 1/4"  
**03072** | Materia Shimmer Nat/Ret  
**03076** | Materia Shimmer Lap/Ret



\*60x119,5 - 24"x47 1/4"  
**02862** | Materia Shimmer Nat/Ret  
**02868** | Materia Shimmer Lap/Ret



\*30x119,5 - 12"x47 1/4"  
**02944** | Materia Raku Warm Nat/Ret  
(handcrafted decor)



90x90 - 36"x36"  
**02982** | Materia Shimmer Grip/Ret



\*89,5x89,5 - 35 1/4"x35 1/4"  
**03469** | Materia Shimmer Nat/Ret  
**03474** | Materia Shimmer Lap/Ret



60x60 - 24"x24"  
**02849** | Materia Shimmer Nat/Ret  
**02855** | Materia Shimmer Lap/Ret



30x60 - 12"x24"  
**02829** | Materia Shimmer Nat/Ret  
**02838** | Materia Shimmer Lap/Ret

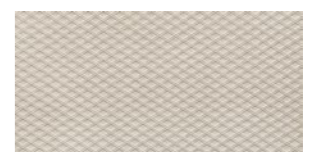

30x60 - 12"x24"  
**02938** | Materia Garage Shimmer Nat/Ret



30x60 - 12"x24"  
**03082** | Materia Tensegrity Shimmer Nat/Ret



20x15 - 8"x6"  
**02989** | Soul Kaleido Light Nat/Ret

\* formato modulare con 60x60 e 30x60 / modular size, can be matched with 60x60 and 30x60 size /  
modulares, sprich mit dem Format 60x60 und 30x60 kombinierbares Format / format modulaire pouvant être coordonné au format 60x60 et 30x60

- Pezzi speciali / Special pieces
- Battiscopa 4,5x60  $\pm$  9,5
  - Gradino Costa Retta 30x119,5  $\pm$  9,5
  - Bacchetta Jolly 1,5x119,5  $\pm$  9,5
  - Unghia Jolly 1,5x1,5  $\pm$  9,5
  - Elemento L 30x90  $\pm$  20
  - Gradone 30x90  $\pm$  20
  - Griglia Scolo 18x90  $\pm$  20



Gres fine porcellanato ad impasto colorato  
Tecnologia Digitale

Coloured-body fine porcelain stoneware  
Digital Technology

Feinsteinzeug aus farbiger Masse  
Digital Technologie

Grès cérame fin à pâte colorée  
Technologie Numérique

# Reflex

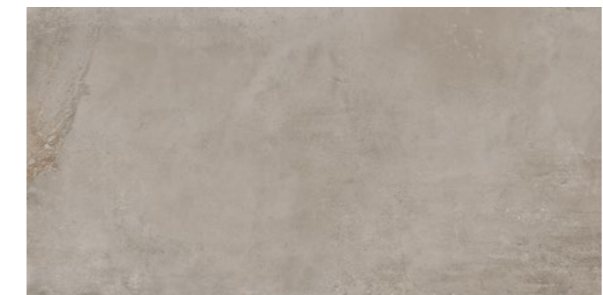

\*60x119,5 - 24"x47 1/2"  
**02863** | Materia Reflex Nat/Ret  
**02869** | Materia Reflex Lap/Ret



\*30x119,5 - 12"x47 1/2"  
**02944** | Materia Raku Warm Nat/Ret  
(handcrafted decor)



90x90 - 36"x36"  
**02983** | Materia Reflex Grip/Ret



60x60 - 24"x24"  
**02850** | Materia Reflex Nat/Ret  
**02856** | Materia Reflex Lap/Ret



30x60 - 12"x24"  
**02831** | Materia Reflex Nat/Ret  
**02841** | Materia Reflex Lap/Ret



30x60 - 12"x24"  
**02939** | Materia Garage Reflex Nat/Ret



30x60 - 12"x24"  
**03083** | Materia Tensegrity Reflex Nat/Ret

\* formato modulare con 60x60 e 30x60 / modular size, can be matched with 60x60 and 30x60 size /  
modulares, sprich mit dem Format 60x60 und 30x60 kombinierbares Format / format modulaire pouvant être coordonné au format 60x60 et 30x60

- Pezzi speciali / Special pieces:
  - Battiscopa 4,5x60 ± 9,5
  - Gradino Costa Retta 30x119,5 ± 9,5
  - Bacchetta Jolly 1,5x119,5 ± 9,5
  - Unghia Jolly 1,5x1,5 ± 9,5
  - Elemento L 30x90 ± 20
  - Gradone 30x90 ± 20
  - Griglia Scolo 18x90 ± 20



# Rust



± 9

119,5×119,5 - 47½"×47½"  
**03073** | Materia Rust Nat/Ret  
**03077** | Materia Rust Lap/Ret



± 9,5

\*89,5×89,5 - 35¼"×35¼"  
**03471** | Materia Rust Nat/Ret  
**03475** | Materia Rust Lap/Ret



± 9,5

60×60 - 24"×24"  
**02851** | Materia Rust Nat/Ret  
**02857** | Materia Rust Lap/Ret



± 9,5

30×60 - 12"×24"  
**02832** | Materia Rust Nat/Ret  
**02843** | Materia Rust Lap/Ret

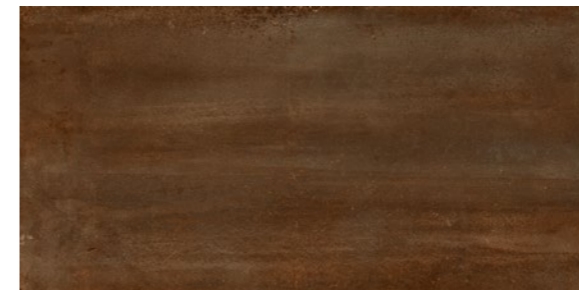

± 9,5

\*60×119,5 - 24"×47½"  
**02864** | Materia Rust Nat/Ret  
**02871** | Materia Rust Lap/Ret



60×60 - 24"×24"

**02945** | Materia Jade Nat/Ret  
(mix 4 graphics)



30×60 - 12"×24"  
**02941** | Materia Garage Rust Nat/Ret

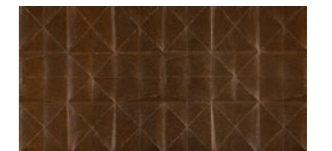

30×60 - 12"×24"  
**03084** | Materia Tensegrity Rust Nat/Ret



\*30×119,5 - 12"×47½"  
**02944** | Materia Raku Warm Nat/Ret  
(handcrafted decor)



20×15 - 8"×6"  
**02990** | Soul Kaleido Dark Nat/Ret

\* formato modulare con 60x60 e 30x60 / modular size, can be matched with 60x60 and 30x60 size /  
modulares, sprich mit dem Format 60x60 und 30x60 kombinierbares Format / format modulaire pouvant être coordonné au format 60x60 et 30x60

Pezzi speciali Special pieces  Battiscopa 4,5×60 ± 9,5  Gradino Costa Retta 30×119,5 ± 9,5  Bacchetta Jolly 1,5×119,5 ± 9,5  Unghia Jolly 1,5×1,5 ± 9,5



# Deep



119,5x119,5 - 47 1/4"x47 1/4"  
**03074** | Materia Deep Nat/Ret  
**03078** | Materia Deep Lap/Ret



\*60x119,5 - 24"x47 1/4"  
**02865** | Materia Deep Nat/Ret  
**02872** | Materia Deep Lap/Ret



\*30x119,5 - 12"x47 1/4"  
**02943** | Materia Raku Cold Nat/Ret  
(handcrafted decor)



90x90 - 36"x36"  
**02984** | Materia Deep Grip/Ret



\*89,5x89,5 - 35 1/4"x35 1/4"  
**03472** | Materia Deep Nat/Ret  
**03476** | Materia Deep Lap/Ret



60x60 - 24"x24"  
**02946** | Materia Zaphire Nat/Ret  
(mix 4 graphics)



60x60 - 24"x24"  
**02852** | Materia Deep Nat/Ret  
**02858** | Materia Deep Lap/Ret

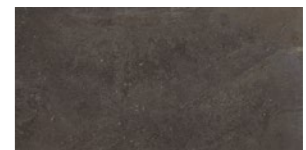

30x60 - 12"x24"  
**02833** | Materia Deep Nat/Ret  
**02846** | Materia Deep Lap/Ret



30x60 - 12"x24"  
**02942** | Materia Garage Deep Nat/Ret

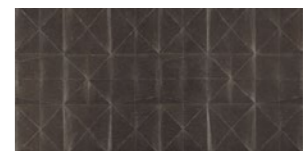









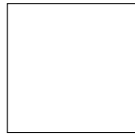
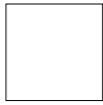
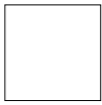

30x60 - 12"x24"  
**03085** | Materia Tensegrity Deep Nat/Ret

\* formato modulare con 60x60 e 30x60 / modular size, can be matched with 60x60 and 30x60 size /  
modulares, sprich mit dem Format 60x60 und 30x60 kombinierbares Format / format modulaire pouvant être coordonné au format 60x60 et 30x60

- Pezzi speciali / Special pieces
- Battiscopa 4,5x60 ± 9,5
  - Gradino Costa Retta 30x119,5 ± 9,5
  - Bacchetta Jolly 1,5x119,5 ± 9,5
  - Unghia Jolly 1,5x1 ± 9,5
  - Elemento L 30x90 ± 20
  - Gradone 30x90 ± 20
  - Griglia Scolo 18x90 ± 20

# Riepilogo Gamma













Collection  
Serie  
Gamme

												
Formati Sizes		*119,5*119,5 - 47¼*47¼"	90*90 - 36*36"	* 89,5*89,5 - 35¼*35¼"	*60*119,5 - 24*47¼"	* 60*60 - 24*24"	* 30*60 - 12*24"	Din 51130	Din 51097	Dcof		
		± 9	± 20	± 9,5	± 9,5	± 9,5	± 9,5					
	Nat/Ret	03071		03468	02859	02847	02827	V2	R10	A+B	>0.42	
	Lap/Ret	03075		03473	02866	02853	02834					
	Nat/Ret				02861	02848	02828	V2	R10	A+B	>0.42	
	Lap/Ret				02867	02854	02836					
	Nat/Ret	03072		03469	02862	02849	02829	V2	R10	A+B	>0.42	
	Lap/Ret	03076		03474	02868	02855	02838					
	Grip/Ret		02982						R11	A+B+C	>0.42	
	Nat/Ret				02863	02850	02831	V2	R10	A+B	>0.42	
	Lap/Ret				02869	02856	02841					
	Grip/Ret		02983						R11	A+B+C	>0.42	
	Nat/Ret	03073		03471	02864	02851	02832	V2	R10	A+B	>0.42	
	Lap/Ret	03077		03475	02871	02857	02843					
	Nat/Ret	03074		03472	02865	02852	02833	V2	R10	A+B	>0.42	
	Lap/Ret	03078		03476	02872	02858	02846					
	Grip/Ret		02984						R11	A+B+C	>0.42	

\*Attenzione: verificare in fase di ordine il codice e l'imballo / Note: In the ordering phase please check code and packaging /  
Bitteachten: Beim Bestellen bitte die Kodenummer und die Verpackung kontrollieren / Attention : Merci de vérifier emballage et la référence au moment de la commande

# Riepilogo Gamma





Collection  
Serie  
Gamme

		Strutture 3D 3D Structures							
Formati Sizes		* Tensegrity 30*60 - 12*24"	* Garage 30*60 - 12*24"	* Platinum 60*60 - 24*24"	* Gold 60*60 - 24*24"	* Jade 60*60 - 24*24"	* Zaphire 60*60 - 24*24"	* Raku 30*119,5 - 12*47¼"	Kaleido 20*15 - 8*6"
		± 9,5	± 9,5	± 9,5	± 9,5	± 9,5	± 9,5	± 9,5	± 9,5
	Nat/Ret	03079	02936	02981				02944	
	Lap/Ret								
	Nat/Ret	03081	02937		02980			02944	
	Lap/Ret								
	Nat/Ret	03082	02938					02944	02989
	Lap/Ret								
	Nat/Ret	03083	02939					02944	
	Lap/Ret								
	Nat/Ret	03084	02941			02945		02944	02990
	Lap/Ret								
	Nat/Ret	03085	02942				02946	02943	
	Lap/Ret								

\*Attenzione: verificare in fase di ordine il codice e l'imballo / Note: In the ordering phase please check code and packaging /  
Bitteachten: Beim Bestellen bitte die Kodenummer und die Verpackung kontrollieren / Attention : Merci de vérifier emballage et la référence au moment de la commande

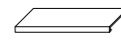
# Riepilogo Gamma

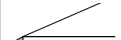
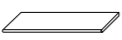
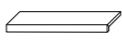
Collection  
Serie  
Gamme

		Pezzi Speciali Special Pieces						
								
		Gradino Costa Retta 30*119,5 - 12*47½"	Battiscopa 4,5*60 - 1¼*24"	Bacchetta Jolly 1,5*119,5 - ¾*47½"	Unghia Jolly 1,5*1,5 - ¾*¾"	Gradone 30*90 - 12*36"	Elemento L 30*90 - 12*36"	Griglia Scolo 18*90 - 7¼*36"
		± 9,5	± 9,5	± 9,5	± 9,5	± 20	± 20	± 20
Formati Sizes	Opal	Nat/Ret	03097	02893	03111	03124		
		Lap/Ret	03104	02899	03117	03131		
Formati Sizes	Nacre	Nat/Ret	03098	02894	03112	03125		
		Lap/Ret	03105	02901	03118	03132		
Formati Sizes	Shimmer	Nat/Ret	03099	02895	03113	03126		
		Lap/Ret	03106	02902	03119	03133		
Formati Sizes	Reflex	Grip/Ret				03137	03141	03149
		Nat/Ret	03101	02896	03114	03127		
Formati Sizes	Rust	Lap/Ret	03107	02903	03121	03134		
		Grip/Ret					03138	03142
Formati Sizes	Deep	Nat/Ret	03102	02897	03115	03128		
		Lap/Ret	03108	02904	03122	03135		
Formati Sizes		Nat/Ret	03103	02898	03116	03129		
		Lap/Ret	03109	02905	03123	03136		
Formati Sizes		Grip/Ret				03139	03143	03152

Pezzi Speciali su Richiesta - Special pieces upon request  
Formstücke auf Anfrage - Pièces spéciales sur demande



Gradone Angolare Sx/Dx 20 mm  
Grip/Ret 30\*90 - 12\*36" ± 20



Griglia Scolo Angolare Sx/Dx 20 mm  
Grip/Ret 18\*90 - 7¼\*36" ± 20

# Imballi

Packing  
Verpackung  
Emballage

Formati Sizes	± MM	Pezzi Scatola Pieces/Box Stck/Karton Carreaux/Boîte	Mq/Scatola Sqmt/Box Qm/Karton M2/Boîte	Kg/Scatola Kgs/Box Kg/Karton Kg/Boîte	Scatole/Paletta Boxes/Pallet Karton/Palette Boîte/Palette	Mq/Paletta Sqmt/Pallet Qm/Pallet M2/Palette	Kg/Paletta Kgs/Pallet Kg/Pallet Kg/Palette	Formato Paletta Size Pallet Format Palette Dim. Palette
* 119,5*119,5 (47½*47½") Nat/Ret - Lap/Ret	P	9	2,86	55,50	22	62,92	1221	132x132x53
90*90 (36*36") Grip/Ret	P	20	0,81	36,50	30	24,3	1095	94x94x105
* 89,5*89,5 (35½*35½") Nat/Ret - Lap/Ret	P	9,5	1,602	36,50	20	32,04	730	94x110x60
* 60*119,5 (24*47½") Nat/Ret	P	9,5	1,434	31,00	30	43,02	930	120x80x75
* 60*119,5 (24*47½") Lap/Ret	P	9,5	1,434	32,00	30	43,02	960	120x80x75
* 60*60 (24*24") Nat/Ret	P	9,5	1,08	21,50	40	43,2	860	120x80x75
* 60*60 (24*24") Lap/Ret	P	9,5	1,08	22,50	40	43,2	900	120x80x75
* 30*60 (12*24") Nat/Ret	P	9,5	1,08	21,50	48	51,84	1032	120x80x75
* 30*60 (12*24") Lap/Ret	P	9,5	1,08	22,50	48	51,84	1080	120x80x75
* 30*119,5 (12*47½") Raku Nat/Ret	P	9,5	0,717	15,50	30	21,51	465	120x80x45
* 60*60 (24*24") Jade - Zaphire - Gold - Platinum Nat/Ret	P	9,5	0,72	14,50	32	23,04	464	120x80x75
* 30*60 (12*24") Garage Nat/Ret	P	9,5	1,08	21,50	40	43,2	860	120x80x75
* 30*60 (12*24") Tensegrity Nat/Ret	P	9,5	1,08	21,50	40	43,2	860	120x80x75
20*15 (8*6") Kaleido Nat/Ret	P	9,5	0,750	15,50	36	-	-	-
Pezzi Speciali / Special Pieces								
30*119,5 (12*47½") Gradino Costa Retta Nat/Ret - Lap/Ret	P	9,5	2	0,717	17,00	20	-	-
4,5*60 (1¼*24") Battiscopa Nat/Ret - Lap/Ret	P	9,5	14	0,378 m.l. 8,40	8,00	80	-	-
1,5*119,5 (¾*47½") Bacchetta Jolly Nat/Ret - Lap/Ret	P	9,5	6	0,108	2,50	48	-	-
1,5*1,5 (¾*¾") Unghia Jolly Nat/Ret - Lap/Ret	P	9,5	6	0,001	0,50	48	-	-
30*90 (12*36") Gradone Grip/Ret	P	20	2	0,54	24,50	36	-	-
30*90 (12*36") Elemento L Grip/Ret	P	20	2	0,54	28,50	27	-	-
18*90 (7¼*36") Griglia Scolo Grip/Ret	P	20	1	0,162	7,50	48	-	-

Materia  
Technical Information

\*Attenzione: verificare in fase di ordine il codice e l'imballo / Note: In the ordering phase please check code and packaging /  
Bitte beachten: Beim Bestellen bitte die Kodenummer und die Verpackung kontrollieren / Attention : Merci de vérifier emballage et la référence au moment de la commande



## Pezzi Speciali

Special pieces  
Formstücke  
Pièces spéciales

Battiscopa Nat/Ret 4,5×60 – 1¼"×24" ± 9,5  
Battiscopa Lap/Ret 4,5×60 – 1¼"×24" ± 9,5

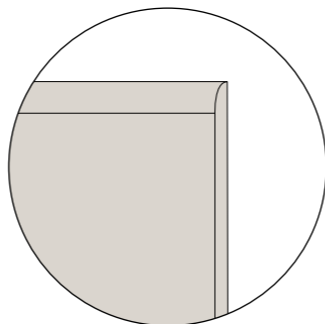
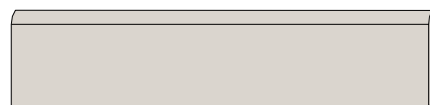

Gradino Costa Retta Nat/Ret 30×119,5 – 12"×47½" ± 9,5  
Gradino Costa Retta Lap/Ret 30×119,5 – 12"×47½" ± 9,5  
(costa retta ottenuto per taglio e incollaggio - obtained by cutting and gluing)

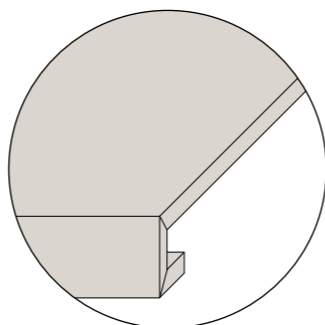
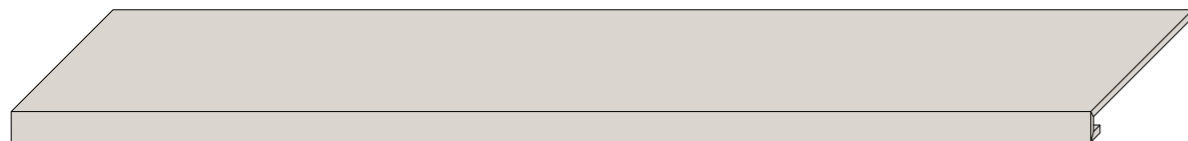

Elemento L 20 mm Grip/Ret 30×90 – 12"×36" ± 20  
(ottenuto per taglio e incollaggio - obtained by cutting and gluing)

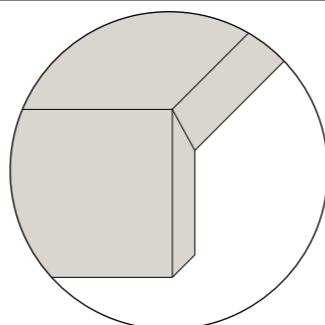

Gradone 20 mm Grip/Ret 30×90 – 12"×36" ± 20  
(toro tecnico - full bullnose edge)

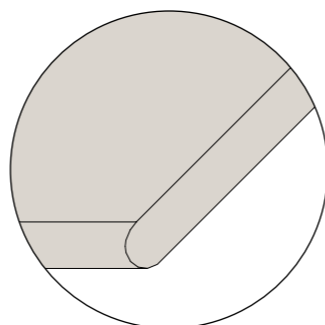
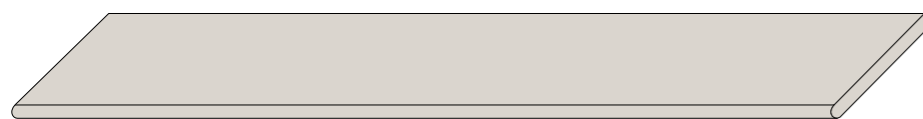

Griglia Scolo 20 mm Grip/Ret 18×90 – 7½"×36" ± 20  
(ottenuto per taglio e incollaggio - obtained by cutting and gluing)

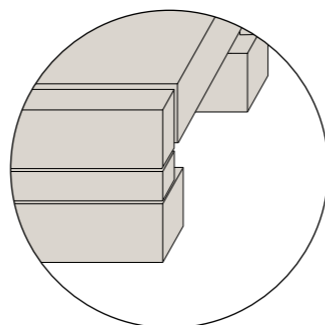

## Pezzi Speciali

Special pieces  
Formstücke  
Pièces spéciales

Bacchetta Jolly Nat/Ret 1,5×119,5 – ⅝"×47½" ± 9,5  
Bacchetta Jolly Lap/Ret 1,5×119,5 – ⅝"×47½" ± 9,5

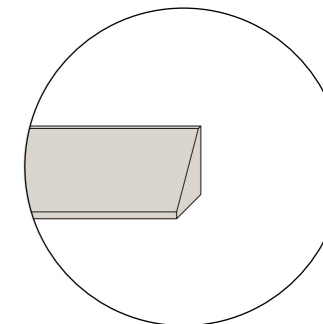
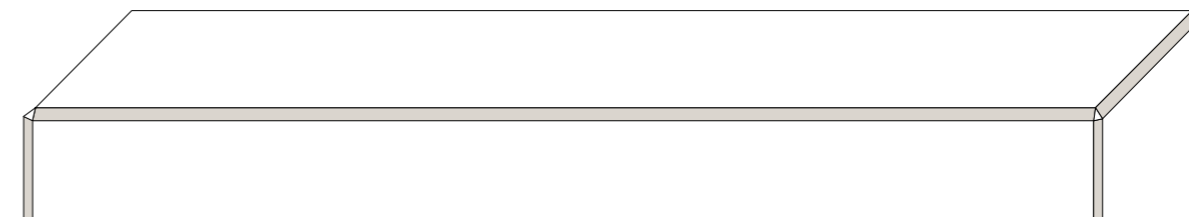

Unghia Jolly Nat/Ret 1,5×1,5 – ⅝"×⅝" ± 9,5  
Unghia Jolly Lap/Ret 1,5×1,5 – ⅝"×⅝" ± 9,5

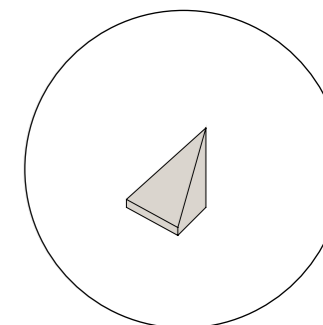
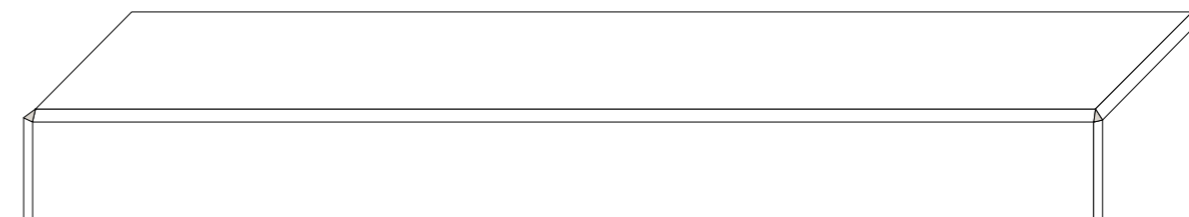

## Elementi di Raccordo Bacchetta e Unghia Jolly

Universal Bevel Filler Strip and Corner Filler Chip  
Verbindungselemente Universalleiste und -aussenecke  
Éléments de raccord baguette et onglet Jolly



Angoli Muretti / Wall Bevel Corners /  
Ecke für Zwischenwände / Angles murets



Spigoli Scale / Staircase Bevel Edge /  
Kanten für Treppen / Arêtes escaliers

# Pezzi Speciali su Richiesta

Special pieces upon request  
Formstücke auf Anfrage  
Pièces spéciales sur demande

Gradone Angolare Sx/Dx 20 mm Grip/Ret 30x90 - 12"x36" ± 20  
(toro tecnico - full bullnose edge)

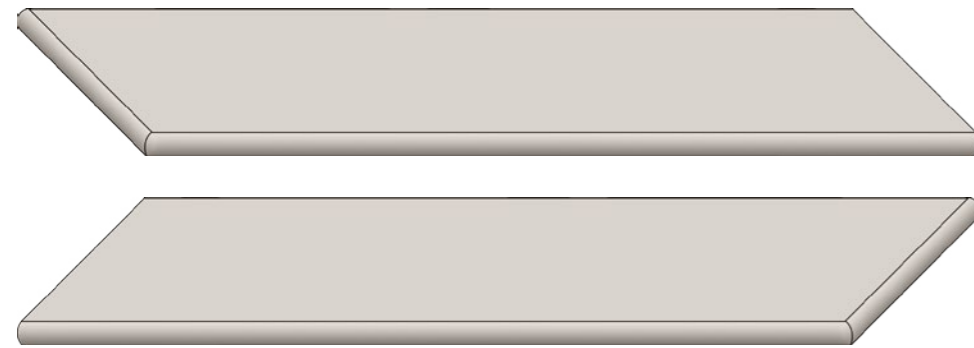

Angolo Sx

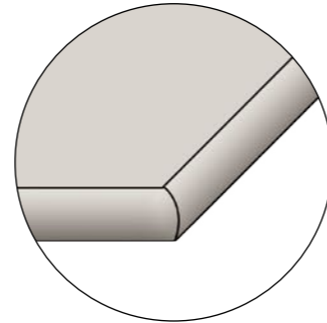

Angolo Dx

Griglia Scolo Angolare Sx/Dx 20 mm Grip/Ret 18x90 - 7 1/4"x36" ± 20  
(ottenuto per taglio e incollaggio - obtained by cutting and gluing)

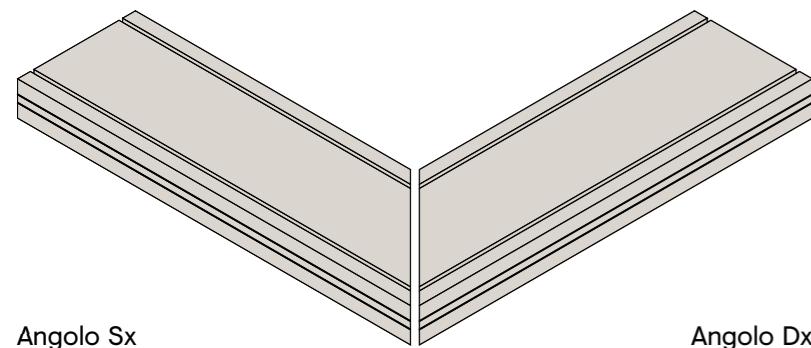

Angolo Sx

Angolo Dx

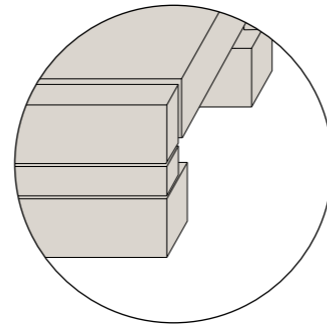

# Caratteristiche Tecniche

Technical characteristics  
Technische daten  
Caracteristiques techniques

CLASSIFICAZIONE SECONDO NORME CEN/ISO GRUPPO B1A EN 14411 - ISO 13006 - CLASSIFICATION IN ACCORDANCE WITH CEN/ISO STANDARDS B1A EN 14411 - ISO 13006  
KLASSIFIZIERUNG GEMÄSS CEN/ISO-NORMEN GRUPPE B1A EN 14411 - ISO 13006 - CLASSIFICATION SELON LES NORMES CEN/ISO GROUPE B1A EN 14411 - ISO 13006

CARATTERISTICA TECNICA TECHNICAL CHARACTERISTIC TECHNISCHE DATE CARACTÉRISTIQUE TECHNIQUE	NORMA NORM NORM NORME	VALORE PRESCRITTO VALUE REQUIRED NORMVORGABE VALEUR PRESCRIPTE	VALORE MEDIO MEAN VALUE MITTELWERT VALEUR MOYENNE CERAMICHE PIEMME FLOOR AND ROOF	USA TESTS ASTM C-499 ASTM C-485 ASTM C-502	VALORE MEDIO MEAN VALUE MITTELWERT VALEUR MOYENNE CERAMICHE PIEMME FLOOR AND ROOF
LUNGHEZZA E LARGHEZZA LENGHT AND WIDTH / LÄNGE UND BREITE / LONGUEUR ET LARGEUR		±0.6% (±2.00 MM)			
SPESORE THICKNESS / STÄRKE / ÉPAISSEUR		±5% (±0.5 MM)			
RETILINEITÀ LATI WARPAGES OF EDGES / GERADHEIT DER KANTEN / RÉCITUDE DES ARÊTES	ISO 10545.2	±0.5% (±1.5 MM)	CONFORME IN ACCORDANCE ERFÜLLT CONFORME		IN ACCORDANCE
ORTOGONALITÀ WEDGING / RECHTWINKLIGKEIT / ORTHOGONALITÉ		±0.5% (±2.00 MM)			
PLANARITÀ FLATNESS / PLANITÄT / PLANIMÉTRIE		±0.5% (±2.00 MM)			
ASSORBIMENTO % D'ACQUA WATER ABSORPTION WASSERANNAHME % ABSORPTION D'EAU %	ISO 10545.3	≤ 0.5%	CONFORME IN ACCORDANCE ERFÜLLT CONFORME	ASTM C-373	IN ACCORDANCE
RESISTENZA ALLA FLESSIONE BENDING STRENGTH BIEGEZUGFESTIGKEIT RÉSISTANCE À LA FLEXION	ISO 10545.4	≥ 35N/MM <sup>2</sup>	CONFORME IN ACCORDANCE ERFÜLLT CONFORME	ASTM C-648 250 LBS OR GREATER	IN ACCORDANCE
DILATAZIONE TERMICA LINEARE TRA 20° E 100° C LINEAR THERMAL EXPANSION BETWEEN 20° AND 100° C LINEARE WÄRMEAUSSDEHNUNG ZWISCHEN 20° UND 100° C DILATATION THERMIQUE LINEAIRE ENTRE 20° ET 100° C	ISO 10545.8	SECONDO I DATI DEL COSTRUTTORE ACCORDING TO BUILDERS SPECIFICATIONS LAUT ANGABEN DES HERSTELLERS SELON LES ELEMENTS DU COSTRUCTEUR	≈ 7X10 <sup>-6</sup> C <sup>-1</sup>		
RESISTENZA AGLI SBALZI TERMICI THERMAL SHOCK RESISTANCE TEMPERATURWECHSELBESTÄNDIGKEIT RÉSISTANCE AUX ÉCARTS DE TEMPÉRATURE	ISO 10545.9	RICHIESTA REQUEST BITTE DEMANDE	RESISTENTE RESISTANT WIDERSTEHEND RÉSISTANT		
RESISTENZA AL GELO FROST RESISTANCE FROSTBESTÄNDIGKEIT RÉSISTANCE AU GEL	ISO 10545.12	RICHIESTA REQUEST BITTE DEMANDE	RESISTENTE RESISTANT WIDERSTEHEND RÉSISTANT	ASTM C-1026	IN ACCORDANCE
RESISTENZA ALL'ATTACCO CHIMICO RESISTANCE TO CHEMICAL ATTACK BESTÄNDIGKEIT GEGEN CHEMIKALIEN RÉSISTANCE À L'ATTAQUE CHIMIQUE	ISO 10545.13	SECONDO I DATI DEL COSTRUTTORE ACCORDING TO BUILDERS SPECIFICATIONS LAUT ANGABEN DES HERSTELLERS SELON LES ELEMENTS DU COSTRUCTEUR	RESISTENTE RESISTANT WIDERSTEHEND RÉSISTANT	ASTM C-650	IN ACCORDANCE
RESISTENZA DEI COLORI ALLA LUCE COLOURS RESISTANCE TO LIGHT LICHTBESTÄNDIGKEIT RÉSISTANCE DES COULEURS À LA LUMIÈRE	DIN 51094	NESSUNA ALTERAZIONE NO ALTERATION KEINE VERÄNDERUNG AUCUNE ALTERATION	CONFORME IN ACCORDANCE ERFÜLLT CONFORME		
RESISTENZA ALLE MACCHIE STAIN RESISTANCE FLECKENFESTIGKEIT RÉSISTANCE AUX TACHES	ISO 10545.14	≥ CLASSE 3 METODO DI PROVA DISPONIBILE TEST METHOD AVAILABLE VERFÜGBARE PRÜFMETHODE METHODE D'ESSAI DISPONIBILE	CONFORME IN ACCORDANCE ERFÜLLT CONFORME		
RESISTENZA ALLO SCIVOLAMENTO SLIPPAGE RESISTANCE RUTSCHSICHERHEIT RÉSISTANCE AU GLISSEMENT	DIN 51130 *	9 ≤ R ≤ 13	NAT LAP GRIP 20MM	R10 ASTM C-1028 * COF ≥ 0.6 DRY ≥ 0.6 WET	NAT LAP GRIP 20MM
	DIN 51097 *	A,B,C	NAT LAP GRIP 20MM	A+B ANSI * 137.1-2012 DCOF > 0.42 WET	NAT LAP GRIP 20MM
PENDULUM SLIP TEST	CS EN 7976-2*	> 36 DRY > 36 WET	NAT LAP GRIP 20MM		

\*TRATTANDOSI DI NORMATIVE NAZIONALI, I METODI DI PROVA, I REQUISITI E LE CLASSIFICAZIONI VARIANO DA PAESE A PAESE. IL VALORE ATTESO DALLA RESISTENZA ALLO SCIVOLAMENTO DELLA PRODUZIONE DI INDUSTRIE CERAMICHE PIEMME S.P.A., PUÒ VARIARE IN BASE AL LOTTO PRODUTTIVO. SPECIFICA DOCUMENTAZIONE È DISPONIBILE SU RICHIESTA.  
TEST METHODS, REQUIREMENTS AND CLASSIFICATIONS DIFFER FROM COUNTRY TO COUNTRY, ACCORDING TO THE NATIONAL REGULATIONS. THE EXPECTED VALUE OF SLIPPAGE RESISTANCE OF PRODUCTS BY INDUSTRIE CERAMICHE PIEMME S.P.A. MAY VARY DEPENDING ON THE PRODUCTION BATCH. SPECIFIC DOCUMENTS ARE AVAILABLE UPON REQUEST.  
PRÜFVERFAHREN, ERFORDERNISSE UND KLASSIFIKATIONEN SIND VERSCHIEDEN VON LAND ZU LAND, GEMÄSS DER NATIONALEN VORSCHRIFTEN. DER ERWARTUNGSWERT DER RUTSCHSICHERHEIT DER PRODUKTE VON INDUSTRIE CERAMICHE PIEMME S.P.A. KANN SICH - JE NACH DER PRODUKTIONSPARTIE - VERÄNDERN. SPEZIFISCHE UNTERLAGEN SIND AUF VERLANGEN ZUR VERFÜGUNG.  
LES MÉTHODES D'ESSAI, LES RÉQUISITIONS ET LES CLASSIFICATIONS CHANGENT DE PAYS À PAYS, SELON LES RÉGLEMENTATIONS NATIONALES. LA VALEUR ATTENDUE DE RÉSISTANCE AU GLISSEMENT DES PRODUITS DE INDUSTRIE CERAMICHE PIEMME S.P.A. PEUT VARIER EN FONCTION DU LOT DE PRODUCTION. UNE DOCUMENTATION SPÉCIFIQUE EST DISPONIBLE SUR DEMANDE.

ELENCO DELLE SERIE CERTIFICATE E CLASSIFICAZIONI DISPONIBILI A RICHIESTA - LIST OF CERTIFIED SERIES AND CLASSIFICATIONS AVAILABLE UPON REQUEST  
LISTE DER GEPRÜFTEN SERIE UND KLASSIFIZIERUNGEN AUF ANFRAGE ERHÄLTLIICH - LISTE DES SERIES CERTIFIÉES ET DES CLASSEMENTS DISPONIBLES SUR DEMANDE



CERAMICHE PIEMME  
FLOOR AND ROOF



# Norme per la posa e la manutenzione

Installation and maintenance instructions

Verlegung, reiningung und pflege

Guide a la pose et l'entretien

<ul style="list-style-type: none"><li>Per i prodotti rettificati consigliamo una fuga di 2 mm per un migliore risultato di posa.</li></ul>	<ul style="list-style-type: none"><li>Per eliminare completamente i residui di posa, che potrebbero compromettere la manutenzione ordinaria e le caratteristiche del prodotto, a posa ultimata, procedere con la pulizia utilizzando prodotti adeguati, a base Acida max 3%, rispettando le indicazioni del produttore. Osservare assolutamente i limiti di tempo indicati nelle istruzioni: un contatto troppo pro lungato con questi prodotti potrebbe provocare il danneggiamento della superficie.</li></ul>	<ul style="list-style-type: none"><li>Riguardo l'utilizzo di materiali ceramici all'esterno, pure riconfermando l'ingelività dei prodotti Piemme in gres porcellanato, in conformità alle vigenti normative europee EN 14411/ISO 13006-ISO 10545.12, occorre attenersi ad alcune fondamentali norme previste per la posa all'esterno, atte a rendere inattaccabili al gelo i predetti pavimenti. Le condizioni più importanti da rispettare sono: le opportune pendenze, le impermeabilizzazioni, i giunti di dilatazione, e l'uso di idonei materiali per la posa.</li></ul>	<p>TIPO DI SPORCO</p> <p>INDICAZIONI PER LA PULIZIA</p>
<ul style="list-style-type: none"><li>Per una migliore resa estetica Piemme consiglia stuccature colorate in tinta con le piastrelle. Verificare, prima dell'utilizzo, la compatibilità ed idoneità dei riempitivi per fughe con il prodotto ceramico.</li></ul>	<ul style="list-style-type: none"><li>Gli eventuali aloni che si dovessero presentare dopo la posa di materiali lappati o levigati si potranno facilmente eliminare utilizzando un prodotto idoneo, a base Alcalina.</li></ul>	<ul style="list-style-type: none"><li>Decorì realizzati con smalti e metalli preziosi è indispensabile proteggere la superficie durante la posa, non utilizzare assolutamente prodotti abrasivi e/o acidi, ma solo acqua e sapone neutro. Il produttore non risponde di eventuali danni a questi preziosi materiali causati da "sfregamenti" durante la posa in opera. Per nessun motivo saranno accettate contestazioni relative a materialeposato.</li></ul>	<p>Birra, Caffè, Gelato, Vino Gommia Pneumatico, Grassi vegetali e animali, Inchiostri, Lampostil Olii Meccanici, Residui di scotch Olio di lino, PennarelloResine Smalti, Tintura per capelli</p> <p>Prodotti a Base Alcalina</p>
<ul style="list-style-type: none"><li>Rimuovere le eccedenze dei riempitivi per fughe quando gli stessi sono ancora freschi.</li></ul>			<p>Cera protettiva anti-abrasione, Depositi calcarei, Macchie di ruggine</p> <p>Prodotti a Base Acida</p>
<ul style="list-style-type: none"><li>Attenersi scrupolosamente alle istruzioni indicate dai produttori dei riempitivi per fughe.</li></ul>			<p>Cera di candela, Residui di scotch</p> <p>Solventi</p>
			<p>Per ulteriori informazioni specifiche consultare l'area tecnica sul sito Piemme: <a href="http://www.ceramichepiemme.it">www.ceramichepiemme.it</a></p>

<ul style="list-style-type: none"><li>For better installation results of rectified products, we suggest 2 mm joint.</li></ul>	<ul style="list-style-type: none"><li>To completely eliminate installation residues, which could negatively affect routine maintenance and product characteristics once installation has terminated, proceed to clean using adequate products, with max. 3% Acid base, following the manufacturer's instructions. Always closely abide by the time limits indicated in the instructions: prolonged contact with these products may cause damage to the surface.</li></ul>	<ul style="list-style-type: none"><li>With regard to the use of ceramic materials outdoors, while once more reiterating that Piemme porcelain stoneware products are frost-proof, in compliance with applicable European standards EN 14411/ISO 13006-ISO 10545.12, a number of fundamental procedures must be followed for outdoor installation, suitable for making the aforementioned floors resistant to frost. The most important aspects are: suitable gradients, waterproofing, expansion joints, and the use of suitable installation materials.</li></ul>	<p>TYPE OF STAIN</p> <p>CLEANING SUGGESTIONS</p>
<ul style="list-style-type: none"><li>For a better aesthetic finish, Piemme recommends using jointing colours that match the tiles.</li></ul>	<ul style="list-style-type: none"><li>Any rims that appear after installing lapped or polished materials can be easily eliminated using a suitable Alkaline-based product.</li></ul>	<ul style="list-style-type: none"><li>Decorations made with glazes and precious metals It is most important to protect the surface during installation. Never use abrasive and/or acid products, only water and neutral soap. The manufacturer disclaims liability in case of any damage to these precious materials caused by "rubbing" during installation. Under no circumstances will disputes be accepted relating to the installed material.</li></ul>	<p>beer, coffee, wine, ice cream vegetable and animal fats, rubber, remains of scotch tape, grease from machines, linseed oil, felt tip pens, paints, inks, hair dye</p> <p>Alkaline-based detergent</p>
<ul style="list-style-type: none"><li>Please check, before using, the compatibility and suitability of grouting material with the ceramic tile.</li></ul>			<p>protective anti-abrasion wax, calcareous residuals, rust stains</p> <p>Acid-based detergent</p>
<ul style="list-style-type: none"><li>Clean away the excess of grouting materials while they are still fresh.</li></ul>			<p>candle wax, remains of scotch-tape</p> <p>Solvents</p>
<ul style="list-style-type: none"><li>Follow carefully the instructions pointed out by the producers of tile grouting materials.</li></ul>			<p>For further specific details please visit the technical area on Piemme website: <a href="http://www.ceramichepiemme.it">www.ceramichepiemme.it</a></p>

<ul style="list-style-type: none"><li>Damit sich eine bessere Verlegung von geschliffenen Produkten ergibt, empfehlen wir eine Fugenbreite von 2 mm.Für ein optisch perfektes Ergebnis empfiehlt Piemme, die Fugen farblich auf die Fliesen abzustimmen.</li></ul>	<ul style="list-style-type: none"><li>Zur vollkommenen Entfernung der Verlegerückstände, die die normale Pflege erschweren und die Merkmale des Produkts beeinträchtigen könnten, nach der Verlegung geeignete Reinigungsmittel auf max. 3% Säurebasis verwenden und bei der Reini gung die Hinweise des Herstellers beachten. Die angegebenen Zeiten keinesfalls überschreiten: ein zu lange andauernder Kontakt mit diesen Produkten kann Beschädigungen der Oberfläche verursachen.</li></ul>	<ul style="list-style-type: none"><li>Auch wenn die Piemme-Feinsteinzeugprodukte gemäß den europäischen Normen EN 14411/ISO 13006-ISO 10545.12 frostbeständig sind, müssen beim Einsatz keramischer Materialien im Freien einige Grundregeln beachtet werden, damit die Bodenbeläge nicht vom Frost angegriffen werden können. Die wichtigsten Voraussetzungen sind: korrektes Gefälle, Abdichtung, Dehnungsfugen sowie geeignetes Verlegematerial.</li></ul>	<p>VERSCHMUTZUNGSART</p> <p>REINIGUNGSHINWEISE</p>
<ul style="list-style-type: none"><li>Prüfen sie bitte, vor der Verwendung, die Zweckmäßigkeit und die Verträglichkeit des Fugenfüllmittels mit den Keramikfliesen.</li></ul>	<ul style="list-style-type: none"><li>Eventuelle nach der Verlegung von geläpptem oder geschliffenem Material sichtbare Schleier lassen sich einfach mit entsprechenden, alkalischen Produkten entfernen.</li></ul>	<ul style="list-style-type: none"><li>Dekore mit Glasuren und Edelmetallen Während der Verlegung muss die Oberfläche unbedingt abgedeckt werden. Es dürfen keine scheuernden und/oder säurehaltigen Produkte verwendet werden, sondern ausschließlich Wasser und neutrale Seife. Der Hersteller haftet nicht für eventuelle, während der Verlegung durch Abrieb entstandene Schäden an diesen hochwertigen Materialien. Reklamationen von bereits verlegtem Material werden in keinem Fall akzeptiert.</li></ul>	<p>Bier, Wein, Eis, Kaffee Tierische oder pflanzliche Fette Gummi, Kleberbandresten Schmieröl, Tinte, Leöl, Filzstift, Harz oder Lack, Haarfarbe</p> <p>Alakalische Reinigungsmittel</p>
<ul style="list-style-type: none"><li>Bitte entfernen sie das überflüssige Fugenfüllmittel wenn es noch frisch ist.</li></ul>			<p>Kratzenschutz-Wachs, Kalkablagerunge, Rostflecken</p> <p>Säure-Reinigungsmittel</p>
<ul style="list-style-type: none"><li>Folgen sie bitte sorgfältig die von dem Herstellern des Fugenfüllmills angegebenen Bedienungsvorschriften.</li></ul>			<p>Kerzenwachs Kleberbandresten</p> <p>Lösungsmittel</p>
			<p>Weitere Einzelheiten finden Sie in dem technischen Bereich des Piemme website: <a href="http://www.ceramichepiemme.it">www.ceramichepiemme.it</a></p>

<ul style="list-style-type: none"><li>Pour obtenir le meilleur résultat de pose de produits rectifiés, il est conseillé de réaliser un joint de 2 mm.</li></ul>	<ul style="list-style-type: none"><li>Pour éliminer complètement tout résidu de pose pouvant gêner l'entretien courant et altérer les caractéristiques du produit, il est conseillé, à la fin de la pose, de procéder au nettoyage du carrelage avec des produits à base acide maximum 3% et de respecter les consignes du fabricant. Suivre impérativement les délais indiqués dans la notice car le contact trop prolongé de ces produits pourrait endommager la surface.</li></ul>	<ul style="list-style-type: none"><li>Pour ce qui est de la pose à l'extérieur, bien que les produits Piemme en grès cérame soient ingélifs, conformément aux normes européennes EN 14411/ISO 13006-ISO 10545.12, il convient cependant de respecter quelques règles fondamentales de manière à rendre le carrelage inattaquable au gel. Les conditions les plus importantes à remplir sont: le degré d'inclinaison, l'imperméabilisation, les joints de dilatation et l'utilisation de matériaux de pose appropriés.</li></ul>	<p>TYPE DE TACHE</p> <p>NETTOYAGE CONSEIL</p>
<ul style="list-style-type: none"><li>Pour parfaire l'effet esthétique obtenu, Piemme conseille de confectionner des joints de la même couleur que les carreaux.</li></ul>	<ul style="list-style-type: none"><li>Pour éliminer facilement la présence éventuelle de cernes après la pose de carreaux rodés ou polis, utiliser un produit à base alcaline.</li></ul>	<ul style="list-style-type: none"><li>Décors réalisés avec des émaux et des métaux précieux Il est indispensable de protéger la surface pendant la pose. N'utiliser en aucun cas des produits abrasifs et/ou acides mais uniquement de l'eau et du savon neutre. La fabricant ne répond pas des dommages éventuels de ces matériaux précieux causés par le frottement pendant la pose. Aucune réclamation, quelle qu'elle soit, concernant le matériau posé ne sera acceptée.</li></ul>	<p>Bière, Vin, Glace, Café, Graisses végétales et animales, Encres, Résidus de scotch, Huile de graissage, Hile de lin Crayon feutre Émaux, Teinture pour cheveux, Caoutchouc pour pneus</p> <p>Détergents à base alcaline</p>
<ul style="list-style-type: none"><li>Vérifier avant la pose la compatibilité et convenance des remplissages pour joints avec le produit céramique.</li></ul>			<p>Cire de protection anti abrasion, Dépôts de calcare, Tache de rouille</p> <p>Détergents à base d'acide</p>
<ul style="list-style-type: none"><li>Enlever les surplus des remplissages pour joints alors qu'ils sont encore frais.</li></ul>			<p>Cire de bougie Résidus de scotch</p> <p>Solvant</p>
<ul style="list-style-type: none"><li>Respecter scrupuleusement les instructions indiquées par les fabricants de remplissages pour joints.</li></ul>			<p>Pour d'ultérieures Information spécifiques consulter le département technique du site Piemme: <a href="http://www.ceramichepiemme.it">www.ceramichepiemme.it</a></p>

# Guida alla Lettura

Reading Guide

Leseanleitung

Guide à la lecture

<p><b>▼</b></p> <p><b>▲</b></p>	<p><b>Spessore</b></p> <p><b>Thickness</b></p> <p><b>Stärke</b></p> <p><b>Epaisseur</b></p>	<p><b>Variazione nelle sfumature di colore</b></p> <p><b>Color shade variations</b></p> <p><b>Variation der Farbnuancen</b></p> <p><b>Variation des nuances de couleur</b></p>	<p><b>Resistenza alla scivolosità</b></p> <p><b>Skid resistance</b></p> <p><b>Rutschfestigkeit</b></p> <p><b>Resistance au glissement</b></p>
<p>V1</p>		<p><b>Aspetto uniforme</b></p> <p><b>Uniform apperance</b></p> <p><b>Gleichförmiges aussehen</b></p> <p><b>Aspect uniforme</b></p>	
<p>V2</p>		<p><b>Variazione leggera</b></p> <p><b>Slight variation</b></p> <p><b>Leichte variation</b></p> <p><b>Variation légère</b></p>	
<p>V3</p>		<p><b>Variazione moderata</b></p> <p><b>Moderate variation</b></p> <p><b>Mäßige variation</b></p> <p><b>Variation modeste</b></p>	
<p>V4</p>		<p><b>Variazione casuale</b></p> <p><b>Random variation</b></p> <p><b>Zufällige variation</b></p> <p><b>Variation fortuite</b></p>	

<p>Tutti i formati sono nominali.</p>	<p>All sizes are nominal.</p>	<p>Die Formate sind Nennwerte.</p>	<p>Tous les formats sont nominaux.</p>
<p>Gli spessori riportati in questo catalogo sono nominali e possono variare a seconda dei formati e delle finiture.</p>	<p>The thickness mentioned on this catalogue are nominal and can be different according to the sizes and the finishes.</p>	<p>Die in diesem Katalog angegebenen Fliesenstärke sind nominal und können, je nach Format oder Oberfläche, verschieden sein.</p>	<p>Les épaisseurs reportées sur ce catalogue sont nominales et peuvent varier suivant les formats et les finitions.</p>
<p>I colori e le caratteristiche estetiche dei prodotti sono quanto più possibile vicini a quelli reali, nei limiti consentiti dai processi di stampa.</p>	<p>The colours and appearance features of the products are as close as possible to reality, within the limitation of the printing process.</p>	<p>Die Farben und die ästhetischen Eigenschaften der Produkte entsprechen der Wirklichkeit, innerhalb den von dem Druckverfahren erlaubten Grenzen.</p>	<p>Les couleurs et les caractéristiques esthétiques sont fidèles aux couleurs et caractéristiques réelles dans les limites des procédés d'impression.</p>



Ceramics of Italy rappresenta la volontà dell'industria italiana delle piastrelle di ceramica nel diffondere e promuovere una nuova valenza della piastrella di ceramica: non più solo un prodotto per l'industria delle costruzioni, ma punto di riferimento per stile e creatività per lo sviluppo di una nuova cultura dell'abitare Made in Italy.

Ceramics of Italy represents the willingness of the Italian ceramic tile industry to spread and promote a new concept of ceramic tile: no longer just a product for the construction industry, but a focal point for style and creativity in the development of a new culture of living Made in Italy.

Project Management  
Mktg Piemme

#### Una storia tutta italiana

Piemme dal 1962, anno della sua fondazione, è protagonista indiscussa del vero Made in Italy, quello fatto di eccellenza, passione e creatività. Oggi tutti i materiali Piemme sono prodotti con tecnologia d'avanguardia come la decorazione digitale inkjet HD, la cottura in forni ad energia pulita a recupero di calore, la rettifica e levigatura in linea "one roof" e la verifica elettronica dello standard qualitativo.

#### An all-Italian story

Since 1962, the year of its foundation, Piemme has been the undisputed protagonist of real Made in Italy, that which consists of excellence, passion and creativity. Today, all Piemme materials are made using cuttingedge technology such as HD inkjet digital decoration, firing in heat-recycling cleanenergy kilns, "one roof" grinding and polishing line and electronic quality standard control.

#### Eine ganz italienische Geschichte

Seit dem Gründungsjahr 1962 ist Piemme ein unangefochtener Hauptakteur des echten Made in Italy: jenem, das auf Exzellenz, Leidenschaft und Kreativität gründet. Alle Piemme Erzeugnisse werden heute unter Einsatz von Spitzentechnologie produziert, wie zum Beispiel mit der digitalen Inkjet-Dekoration, dem Brennen in Öfen mit grüner Energie und Wärmerückgewinnung, dem Schleifen und Polieren in der Linie „unter einem Dach“ sowie der elektronischen Prüfung des Qualitätsniveaus.

#### Une histoire toute italienne

Depuis 1962, l'année de sa fondation, Piemme est la protagoniste indiscutée du Made in Italy, basé sur l'excellence, la passion et la créativité. Aujourd'hui toutes les phases du cycle de fabrication Piemme sont issues d'une technologie à l'avant-garde comme la décoration numérique inkjet HD, la cuisson dans des fours à énergie propre et à récupération de chaleur, la rectification et le polissage en en ligne "one roof" et la vérification électronique de la qualité.

# Z

COLLECTION

**Order Desk and Customer Service:**

**503.419.9786**

**orderdesk@zcollection**

**zcollection.com**